

WARNING: Danger of Scalding!



Recognized mark of the steam release

THANE *HOUSEWARES*[™]



M O P

USER'S GUIDE

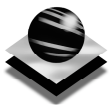

Thane International, Inc.
La Quinta, CA 92253
www.thane.com

Distributed by:
Thane Direct Canada
Toronto, Canada
www.thane.ca

Thane Direct UK Ltd.
Admail ADM3996, London, W1T 1ZU
www.thanedirect.co.uk

Copyright 2004 Thane International, Inc.
Thane Housewares is a division of Thane International, Inc.
MADE IN CHINA

H20M-E-R2 (may 24, 2007)

THANE *HOUSEWARES*[™]



M O P

USER'S GUIDE

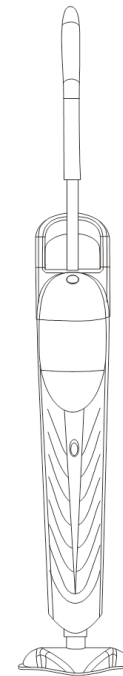

MODEL:
808.092

• IMPORTANT SAFETY INFORMATION •
READ ALL INSTRUCTIONS BEFORE USING STEAM CLEANER
USE ONLY AS DIRECTED.



IMPORTANT SAFEGUARDS

PLEASE READ CAREFULLY

When using an electric appliance, basic precautions should always be followed, including the following:

READ ALL INSTRUCTIONS BEFORE USING THIS STEAM CLEANER

WARNING – DANGER OF SCALDING

CAUTION - To reduce the risk of fire, electric shock, or injury:

- To provide continued protection against risk of electric shock, connect to properly grounded outlets only.
- Check that the main voltage corresponds to the voltage indicated on the rating label, see specifications below:
110~120V, 60HZ, 1500W
220~230V, 50/60HZ, 1500W
- This product is designed for domestic use only.
- Do not use outdoors.
- Do not leave the H2O Mop unattended while switched on. Turn off the switch and unplug the electrical cord when not in use and before servicing.
- Do not allow to be used as a toy. Close attention is necessary when used near children, pets or plants.
- The appliance is not intended for use by young children or infirm persons without supervision.
- Young children should be supervised to ensure that they do not play with the appliance.
- Never direct steam towards people, animals or plants, or equipment containing components.
- Do not immerse the H2O Mop into water or other liquids.
- Do not use with damaged cord or plug. If the H2O Mop is not working as it should, has been dropped, damaged, left outdoors, or immersed into water, return it to the distributor before continuing use. If the supply cord is damaged, it must be replaced by the manufacturer or a similarly qualified person to avoid a hazard.
- Do not pull or carry by cord, use cord as a handle, close a door on the cord, or pull cord around sharp edges or corners. Keep cord away from heated surfaces.
- Never force the plug into an outlet.
- Do not use extension cords or outlets with inadequate current carrying capacity.
- Unplug after use. Do not unplug by pulling on cord. To unplug, grasp the plug, not the cord.
- Do not handle plug or H2O Mop with wet hands or operate without shoes.
- Do not insert any objects into openings. Do not use with any opening blocked.
- Do not use without floor cloth in place. Do not use without water in the water tank.
- When using on stairs use extra caution.
- Store your H2O Mop indoors in a cool, dry area.
- Keep your work area well lighted.
- Never put cleaning detergents into the H2O Mop. This will make the operation unsafe and damage the unit.
- Never block the steam openings of the product or place it on a soft surface, where the steam openings may be blocked. Keep the steam openings free of lint, hair, and the like.
- Use only as described in this manual. Use only manufacturer's recommended accessories.

SAVE THESE INSTRUCTIONS



15) When the H2O Mop stops emitting steam, this will occur after approximately 20 minutes of use, turn off the H2O Mop and simply remove the Water tank, refill, and then again turn on and continue cleaning.

WARNING: NEVER run the H2O Mop without water. NEVER direct steam at any person or animal. Use the H2O Mop on sealed hard floor only.

16) When you finish your cleaning, unplug Power cord from outlet, empty the Water tank, carefully remove the Cloth Pad from the head, wind Power Cord around the Cord Wrap and store it upright in a dry area or hang by the storage hook.

CAUTION: The Cloth Pad may be very hot.
Not for space heating purpose.

CLEANING AND MAINTENANCE

CAUTION: Prior to cleaning or maintenance isolate the unit by removing the cord from the power socket. Do not immerse the unit in water.

- Microfiber Cloth Pad can be machine washed in hot water and tumbled dry.
- Wipe the steamer with a soft cloth.

The H2O Mop should only be used with its own specially developed floor cloths and Filter (spare Cloth Pads and Filters are available from your retailer).

TROUBLESHOOTING GUIDE

CAUTION: Prior to troubleshooting isolate the unit by removing the cord from the power socket.

Problem

LED is not on.

The H2O Mop will not produce steam.

Pale residue left on the floor.

Solution

Ensure the H2O Mop power cord is correctly plugged into power outlet and power trigger is turned on. Ensure circuit breaker is operational. Try operating the H2O Mop from another power outlet.

Ensure the water tank has correct level of water.

Caused by leaving the H2O Mop in the same position for too long. Can be removed with household white vinegar or a decalcifying product. Alternatively reheat the area for one minute and residue should be removed.

CAUTION: Do not overheat area.



9) To remove the Water tank push it up and detach from the body as shown below.

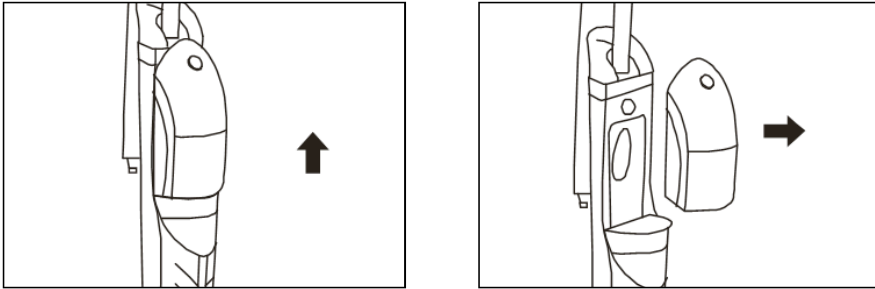

10) Please pour two measuring cups of water into the Water tank (The MAX is 800ml/27oz, do not try to over fill).

11) To remove the Water Filter push it up and detach from the body.

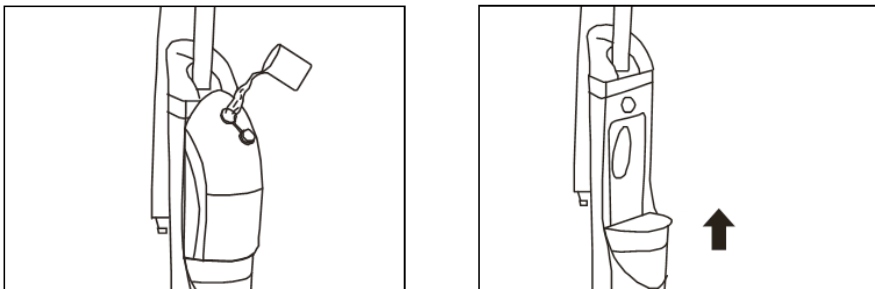

12) Twist the Quick Release Cord Wrap clockwise to unwrap the Power Cord completely and plug into a grounded outlet.

13) When plugged in, the LED light located on the front of the H2O Mop body will be red. After 20-25 seconds, the light will change to green, meaning the Mop is ready to emit steam. To release steam, press the trigger located on the handle, and the unit will start releasing steam. To stop releasing steam, press the trigger again.

14) Slowly pass over surface to be cleaned. It is recommended to sweep or vacuum floor prior using the H2O Mop.

NOTE: It is recommended that another high wattage appliance is not operated on the same circuit to avoid a circuit overload.

CAUTION: To sanitize an area of your floor, leave the H2O Mop over area for a minimum of 8 seconds, but no longer than 15 seconds. Leaving the H2O Mop in a stationary position for a longer period than recommended may cause the build up of a pale residue. This residue can be removed by using a decalcifying product or with a few drops of vinegar. (See troubleshooting guide)



KEY FEATURES OF THE H2O MOP

- A) HANDLE
- B) TRIGGER
- C) CARRY HANDLE
- D) WATER TANK
- E) FILTER
- F) BODY
- G) LED
- H) CORD WRAP
- I) POWER CORD
- J) HEAD
- K) MICROFIBER CLOTH PAD (or disposable pad - optional item)
- L) CARPET GLIDER
- M) MEASURING CUP
- N) LARGE SCREW
- O) SMALL SCREW
- P) 2 BLACK RUBBER SEALS (+2 spares)
- Q) WHITE WASHER (+2 spares)
- R) HANDLE RING

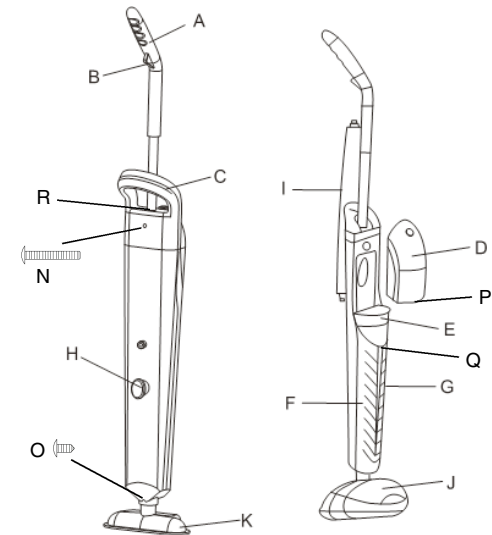
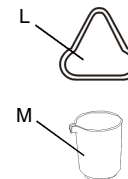

The following information is provided for service by a qualified electrician only:

Rated voltage:

110~120V, 60HZ, 1500W
220~230V, 50/60HZ, 1500W

This appliance must be grounded. Use only the proper type outlet when plugging in the appliance, do not attempt to override the ground wire feature.



Thank you and congratulations for choosing the H2O Mop. The H2O Mop is a new way of cleaning that is effective and far more hygienic than conventional methods. The H2O Mop achieves a high degree of hygienic and increasing cleansing power by converting water into steam using a microfiber floor cloth enhancing absorbency. When contact is made with floor surfaces, dirt and grime can be eliminated in a matter of seconds. Since the H2O Mop uses the active power of steam without the use of detergents or soap, it is environmentally friendly.

When used correctly the H2O Mop can kill dust mites and some types of bacteria. To disinfect a specific area, position the steamer over the area for a minimum of eight seconds. The steam temperature will reach to approximately 90-100°C (194-212°F). Use this procedure to disinfect floors in bathrooms, showers, around kitchen counters, pet sleeping quarters, etc.

INSTRUCTIONS FOR USE

The H2O Mop is designed to thoroughly clean floor surfaces, such as marble, ceramic, stone, linoleum, sealed hardwood floors and parquet.

WARNING: On surfaces that have been treated with wax, the wax may be removed by the heat and steam action. Do not use on unsealed wood floors or let unit stand on any wood floor for an extended period of time. This could cause the wood grain to rise. When using on vinyl, linoleum or any other heat sensitive floors, use extra caution. Too much heat can melt down glue in the flooring. It is therefore recommended that a sample cleansing be carried out on an isolated area of the floor. It is also recommended that you check the use and care instructions of the surface from the floor manufacturer to ensure suitability to steam cleaning.

H2O Mop uses tap water. Residents in areas with hard water, should use distilled water for better performance.

HOW TO ASSEMBLE AND USE

- 1) Attach head to body.
- 2) Secure head with the small Philips Head Screw until it is fully tightened.

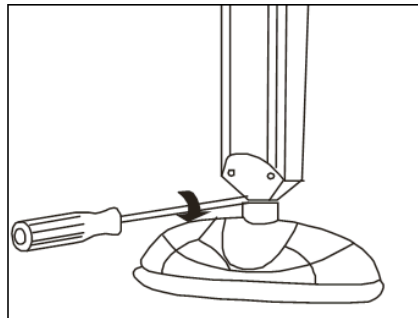
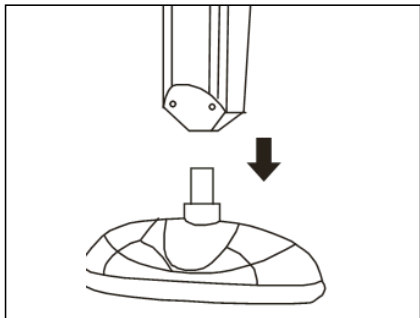

- 3) Insert handle down into the body.
- 4) Once the handle is placed inside the body, slide the silicon ring which is already located on the handle to the bottom. Make sure the ring is positioned tightly so there is no gap between the handle and body.

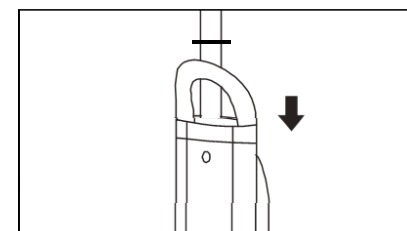
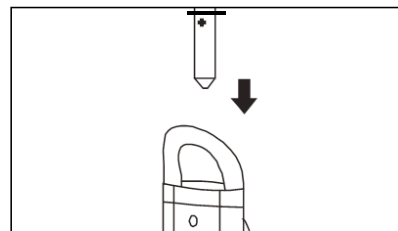

- 5) Screw the Large Philips Head screw through the opening at the back of the body into the rear of the handle, tighten with screwdriver until secure.

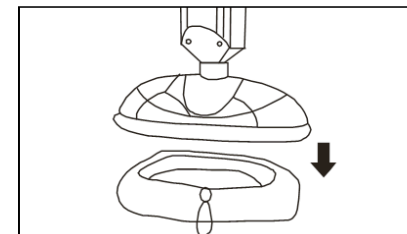
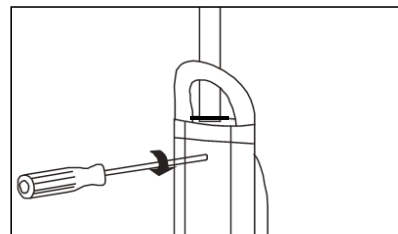

- 6) Place the Microfiber Cloth Pad or disposable pad (optional item) onto the mop head.
Note: Microfiber Cloth is washable while the disposable pad (optional item) is intended for one-time use.
- 7) Fasten the Microfiber Cloth Pad by pulling the cord while pressing on Toggle. Note: this step is not required if you are using disposable pad (optional item). Disposable pad comes with built in elastic cord.
- 8) When using H2O Mop on carpets, place the mop head (with microfiber cloth or disposable pad in place) over the Carpet Glider.

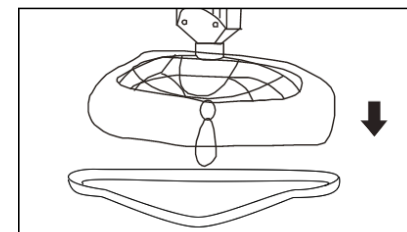
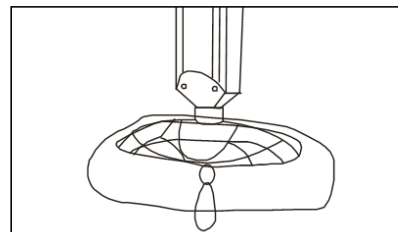

NOTE: Do not operate without either Microfiber Cloth or disposable pad (optional item) in place.